

RESIDENCE PROJECT BROCHURE

The tacit understanding of an elite circle
Returning to the luxury of the family home

On the night of Kandoofa's rooftop garden, a
dreamy family feast begins



Company website: www.kandoofaamv.com

Contact number: +9609500888

Contact address: Kandoofaa Residence, Fithiroanu Magu Lot
11691, Hulhumale, Maldives





"LUXURIOUS RESIDENCE"

project brochure



Contents

Creation · Property Edition

Property Description	03/04
Location and Transportation	05/10
Environmental profile	11/14

Creation · Elite City-State

Exterior wall decoration	17/18
Room interiors	19/28
Pool & Fitness Center	29/30

Creation · Ultimate Experience

Housetable plan	33/40
-----------------	-------

Creation · Property Edition

Kandoofaa: A community of elites

Inspired by I.M. Pei's groundbreaking works Mo Yan's induction into the Nobel Hall of Fame signifies the mastery cultivated over the years. A fusion of Eastern and Western visions.



KANDOOFAA
INVESTMENTS

We understand that true luxury is not only about material abundance, but also about spiritual fulfillment and peace of mind. That's why kandoofaa explores the potential of eco-housing.

Here, you can experience top-notch living in a city closest to the sea, feel the fresh air brought by greenery, and live in harmony with nature.

PROPERTY OVERVIEW

Prestigious and luxurious living experience In KANDOOFAA, every inch of space reflects the pursuit of exquisite craftsmanship and luxurious details. From the artistic decoration of the entrance lobby to the unique and sophisticated design of the house types; from the well-chosen home furnishings to the

unparalleled scenery of the private sea-view balconies, every detail has been carefully planned and designed to provide residents with an unparalleled and honorable experience.



UNIQUE LOCATION

The location of our project in Hulhumalé is unique. Just a 50-meter walk will lead you to admire the magnificent and vast ocean views. Here, you can fully enjoy leisurely moments by the seaside, feeling the moisture of the sea and the changing colors.





Getting Around

Convenient life is one step faster

You can reach Malé in a 20-minute drive from Kandoofaa, the airport in 15 minutes, and anywhere in Malé within 25 minutes, making travel extremely convenient and fast.

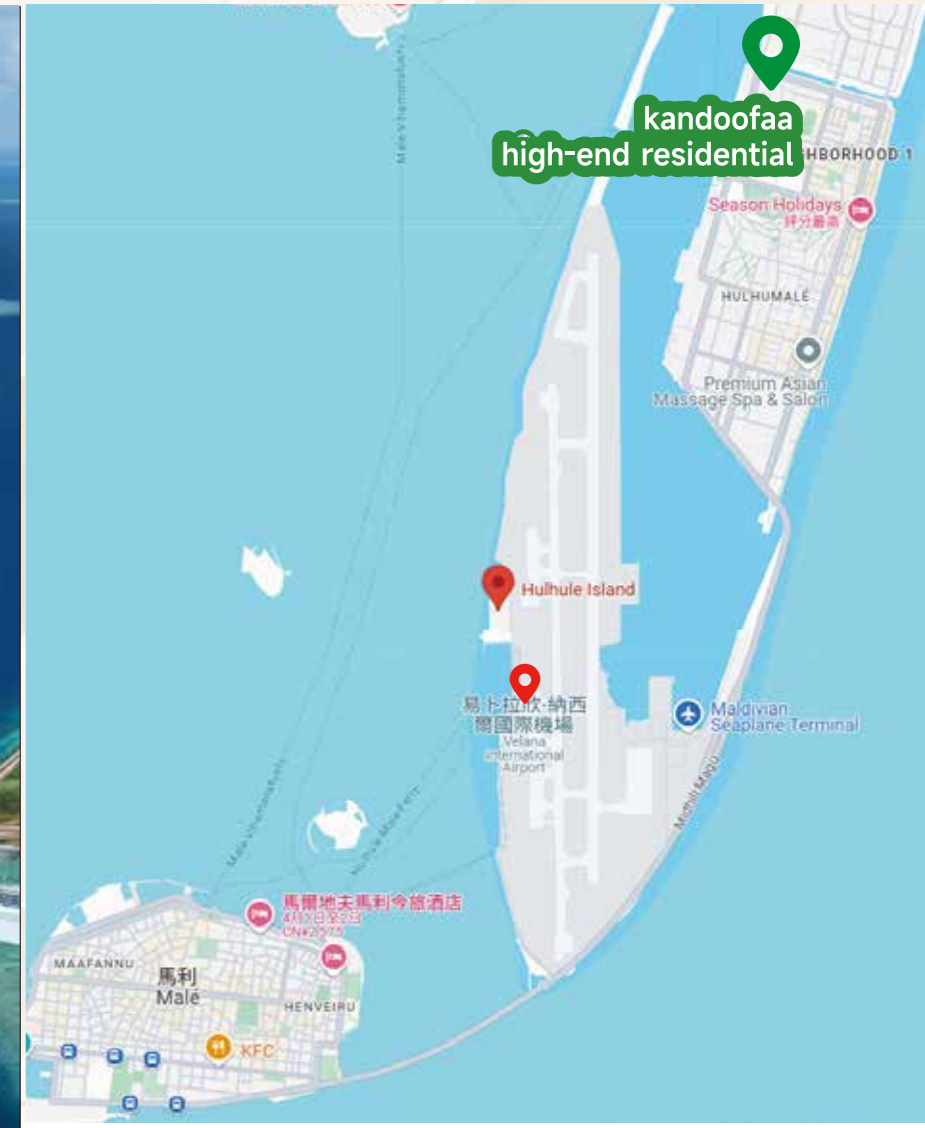



Prosperity, kept at just the right distance

The unique location of our project in Hurumale is one of a kind. Just a 50 metre walk away, you will be able to enjoy a magnificent and expansive view of the ocean. Here you can enjoy a relaxing time by the sea, feeling the moistness of the water and the changing colours.

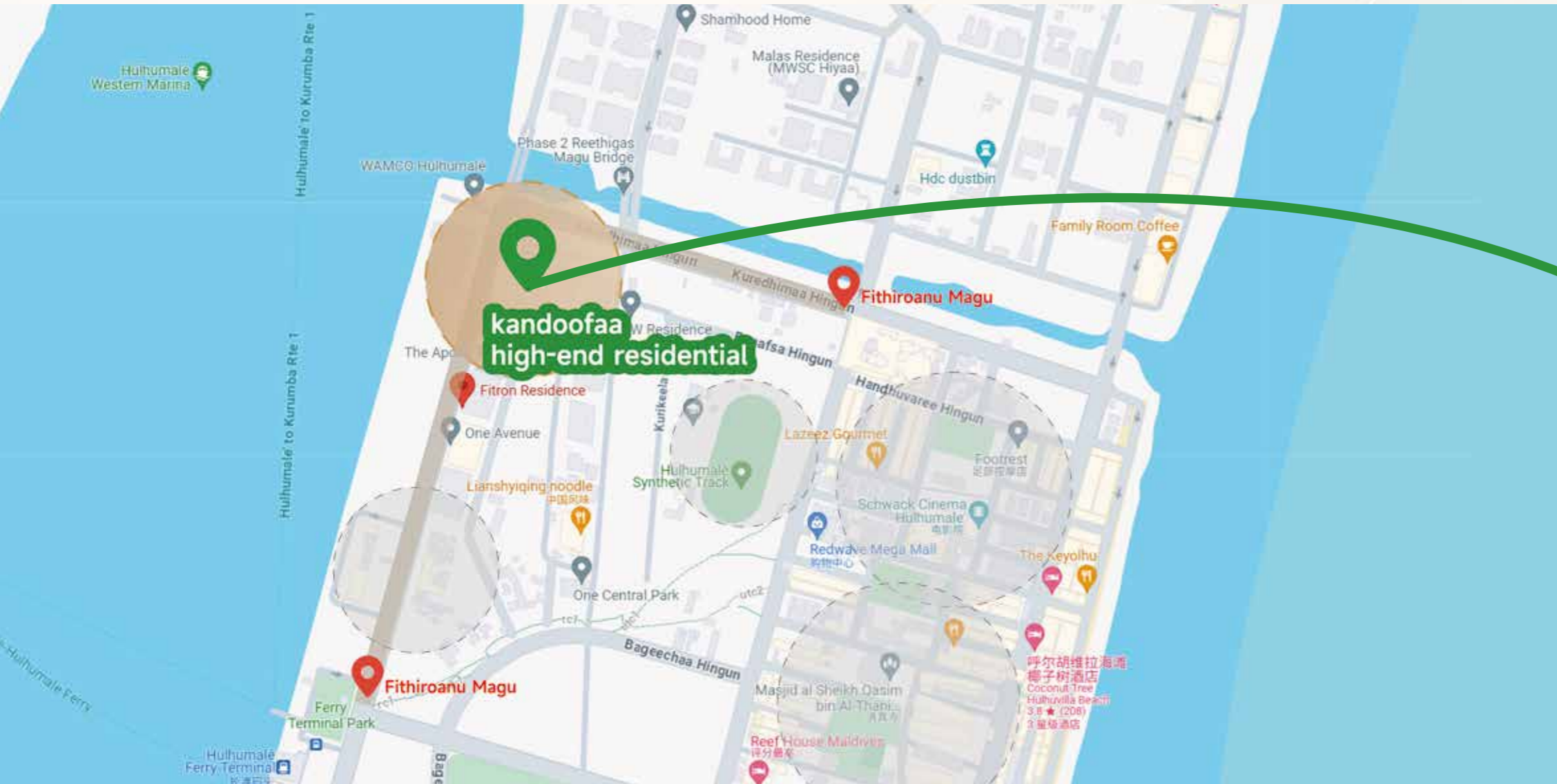



Marina Riverfront Ecological Landscape

Morning sunshine floods the rooms, while twinkling stars illuminate the night, enveloping you in nature's embrace and the ocean's tranquil might. Embracing the sea enriches and enlivens your life.

24 hours in Kandoofaa

ONCE WE SET OUT FOR THE WORLD
NOW WE'RE PROUD TO BE HERE

7:00

Before the dew dries, start the day with a morning walk on the banks of the Kuredhimaa Hingun River.

14:00

In the afternoon, the shadows are swaying, and the elderly people come to the community walkway for a stroll.

17:00

End of a busy day.

10:00

Vibrant and energetic children explore the natural world in a landscaped park

16:00

Sipping afternoon tea while enjoying the gentle sea breeze..

21:30

The stars are shining brightly, so return to your room and look out over the sea to release all the stresses of the day.

Making nature a second classroom for children

Running: The easiest way to cleanse the mind

Creation · Elite City State

In this dynamic world

Every piece of land holds unlimited possibilities.

Creation - Elite City State

Representing a development philosophy

A spirit of excellence and innovation.

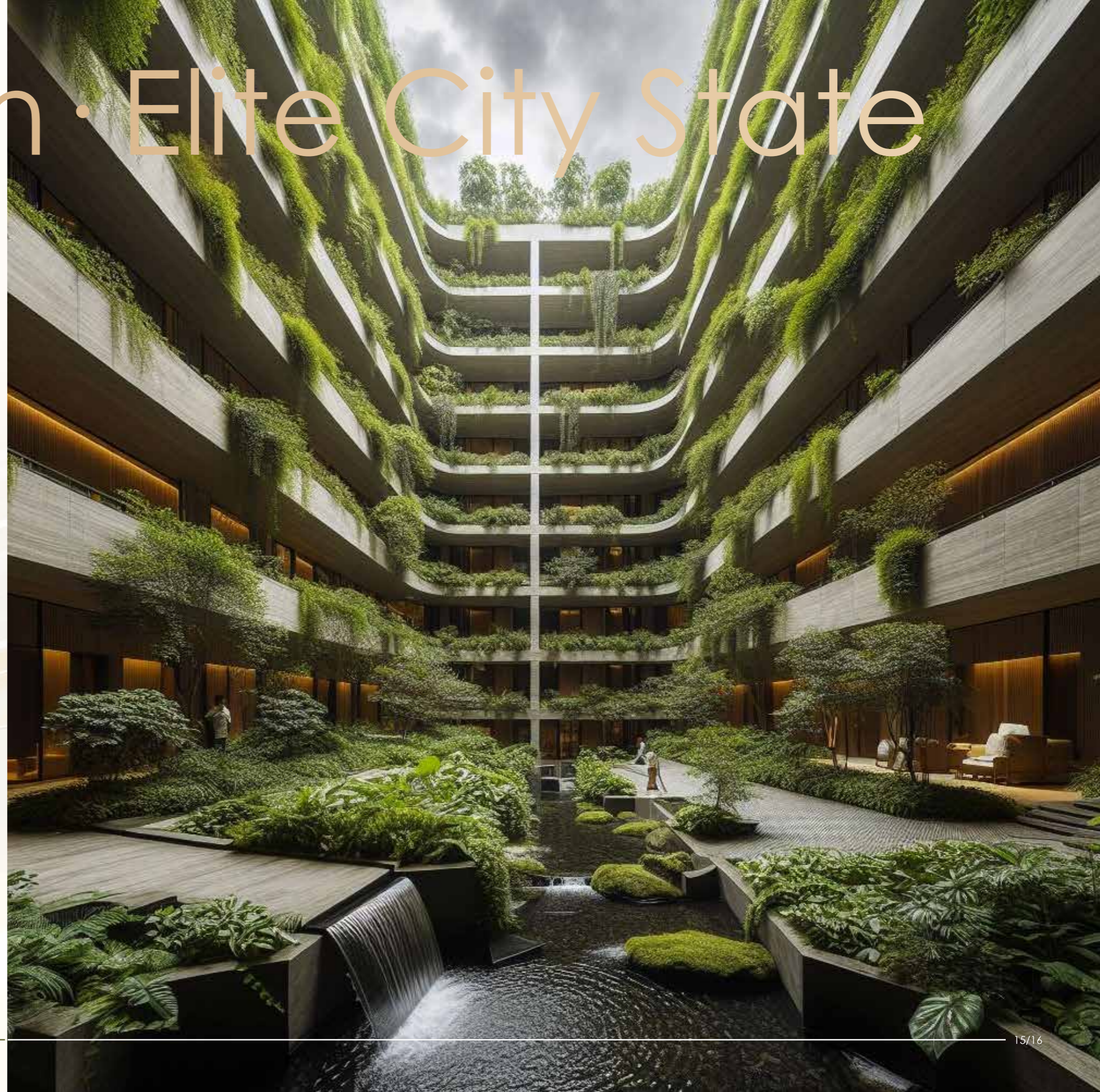

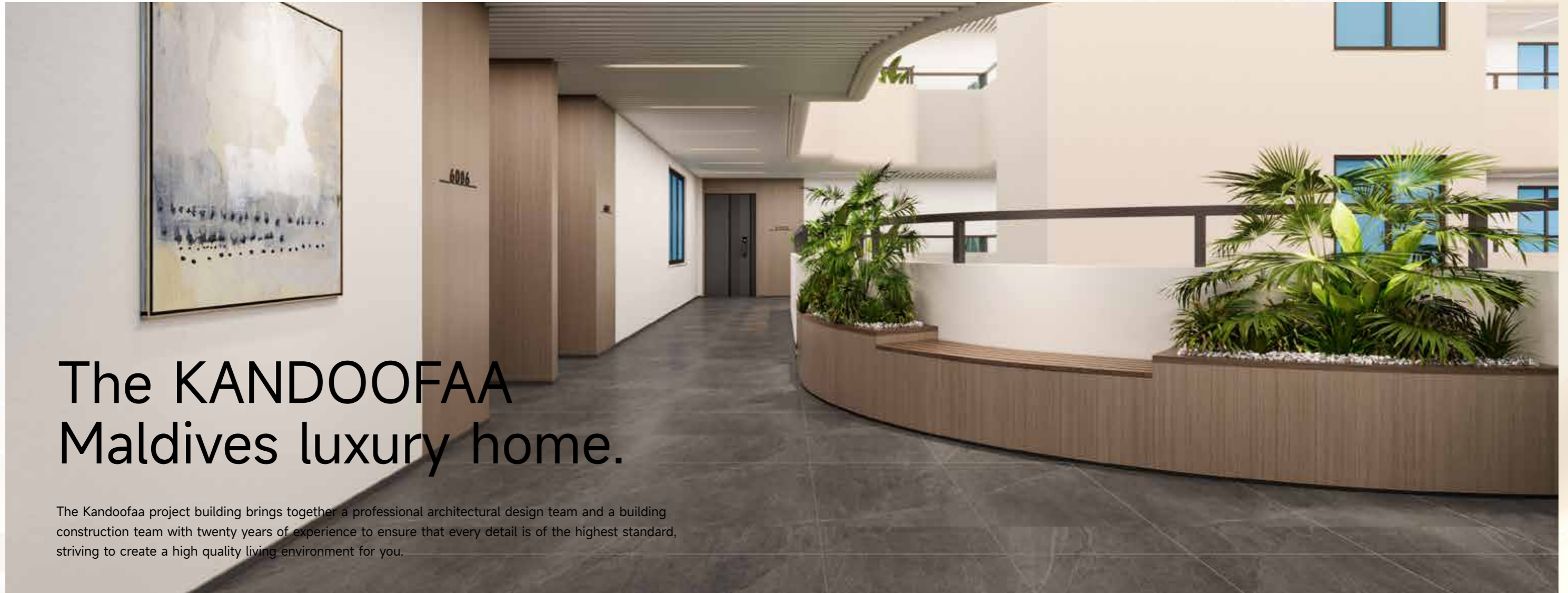

The KANDOOFAA Maldives luxury home.

The Kandoofoo project building brings together a professional architectural design team and a building construction team with twenty years of experience to ensure that every detail is of the highest standard, striving to create a high quality living environment for you.

High-quality facades



High-end exterior real stone paint that is far superior in appearance and quality to traditional latex paint.

Rooftop garden



Rooftop gardens provide a natural sanctuary, a green wonder that can touch the sky.

Exclusive window design



Well-designed windows are able to show the scenery as if in a painting, enhancing your visual enjoyment.

Rational layout of space



Experience how space wizards make every square foot extraordinary and start your journey to your dream home.



Discover the doorway to a privileged life, a life beyond expectations

The unique and exquisite entrance experience for you, allowing you to feel the charm of high quality and design the moment you step into the apartment lobby. Whether it's admiring the decorative details or experiencing the flow of space, we hope to provide you with a perfect visual enjoyment.

Here, every moment makes people feel honourable and elegant. It not only represents a high-end living space, but also a work of art that inspires respect.



Discover top home comfort experiences

Central air conditioning, a key component of modern home design, not only offers comprehensive temperature control for households but also embodies a contemporary lifestyle and forward-thinking home ideals.

Our selected central air conditioning system integrates top features such as high energy efficiency, smart controls, environmental sustainability, and health considerations, aiming to deliver the finest living environment for every family.





Defining the standard of luxury for the future of living

We are not just committed to providing you with a home, but to presenting you with a future lifestyle that combines state-of-the-art technology with luxury and comfort.

Each person's definition of comfort is unique, and the introduction of smart furniture fulfills this need.

Each piece of furniture can be adjusted to your personal preferences, creating an environment that is both environmentally friendly and convenient.



Modern style, leading the future trend of home furnishing.

Behind every inch of the design is our pursuit of perfection and imagination for the future. Our ceiling is not only beautiful and modern, but also creates a warm and comfortable living environment. The simple yet elegant straight lines reflect the owner's unique taste and strict requirements for quality of life.

Our modern ceiling design is not only a revolution in spatial aesthetics, but also a bold vision of future lifestyles. By cleverly blending the latest technology with cutting-edge design, we inject a new sense of vitality and dynamism into your home.





Explore the art of living, and indulge in a luxurious bathroom experience.

We meticulously choose premium materials, blending them with exquisite craftsmanship, striving to harmonize intelligent technology with human-centric design.

From gentle lighting to integrated smart toilets, each element reflects our relentless pursuit of refined living. This space isn't just for daily routines; it's a private sanctuary for relaxation and enjoyment. Here, each day begins and ends with pleasure and comfort. Your life, crafted with care.



◎ Embark on a noble journey towards a stylish and healthier life.

With spacious training areas equipped with a wide variety of fitness equipment, including both classic and cutting-edge models, we aim to inspire your athletic potential and provide you with an efficient and effective workout experience.

Utilizing advanced purification systems, our pools maintain crystal-clear and hygienic water year-round, ensuring a safe and enjoyable swimming experience. Adjacent lounge areas provide the perfect spot to unwind and bask in tranquility.

Creation - Ultimate Experience

Every detail here surpasses imagination and expectations, ushering you into a new realm of luxury. We believe that true luxury transcends material abundance, reaching deep into the heart through ingenious creation.

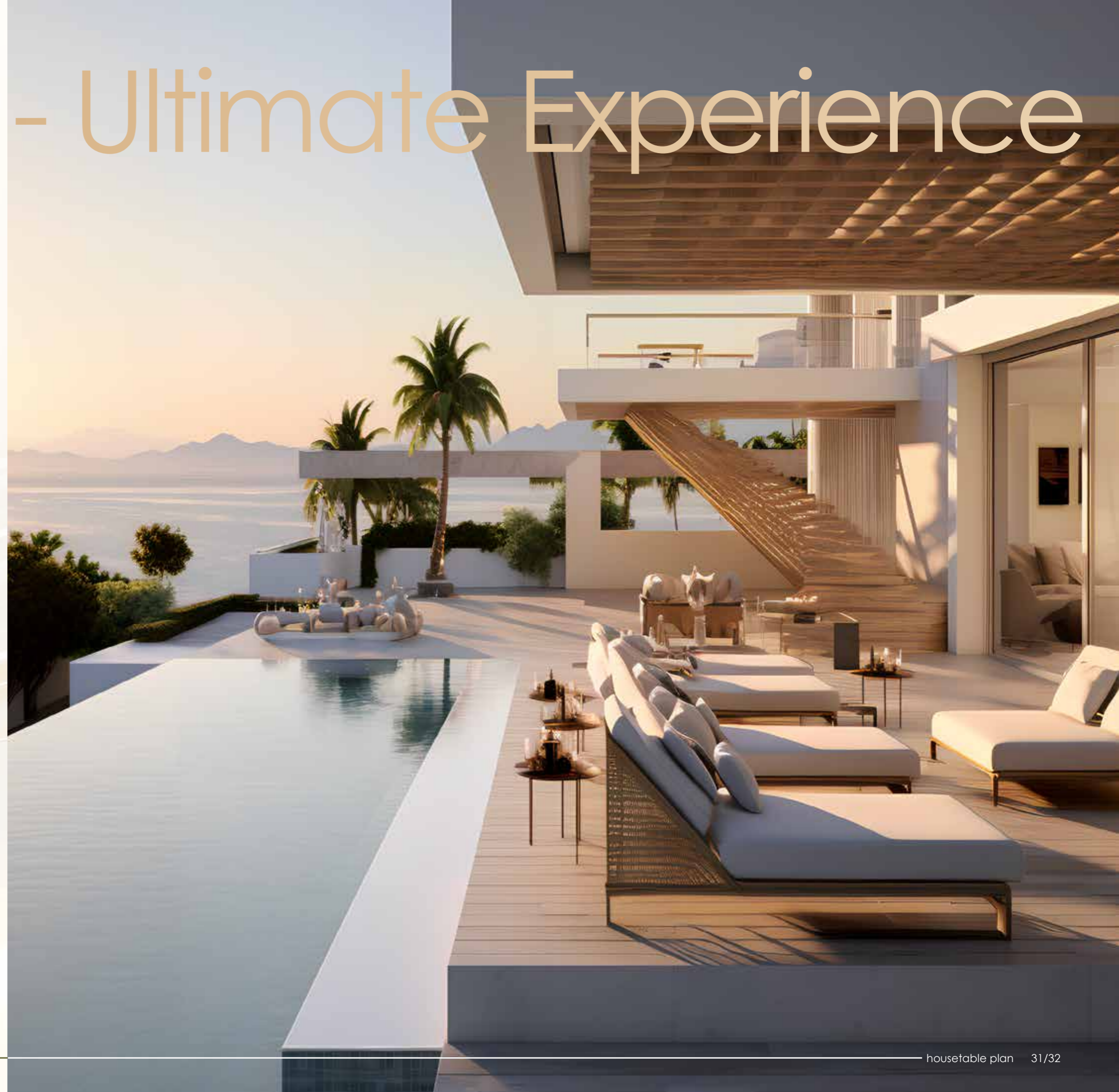

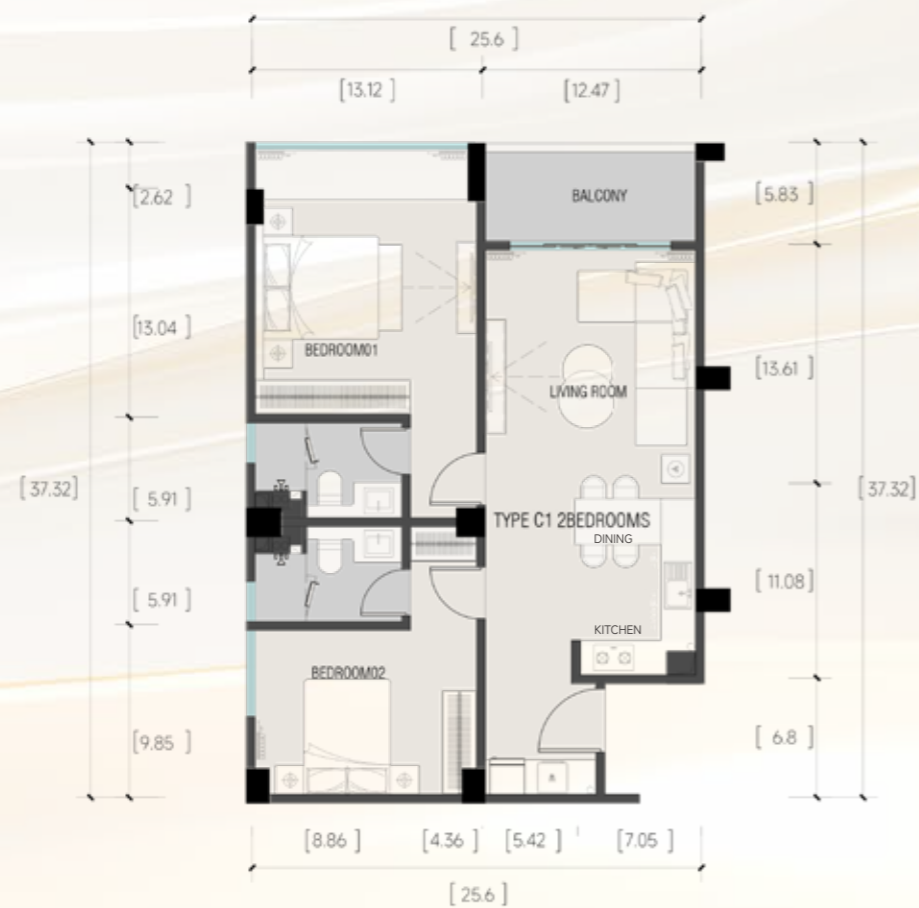

**C1 Layout
2BEDROOM**

Building area
899.22 SQFT

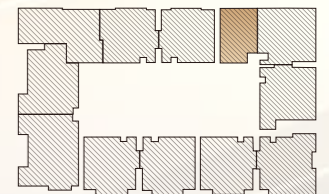

- Two bedrooms
- One living room
- Two bathrooms
- One kitchen
- River view

- **Bright:** North-south ventilation, two-room bright design, wide-view double balconies, embracing the breeze and warm sunshine.
- **Perfection:** Extensive lighting, natural freshness throughout.
- **Luxury:** Transparent layout, private bathrooms for tranquil relaxation.
- **Elegance:** Open kitchen design, free-flowing: Delicately crafted open kitchen design, liberating culinary creativity and care.
- **Utilization:** Every inch of space has been carefully considered: the design is scientific and reasonable, boasting high-performance features, ensuring practicality without waste.

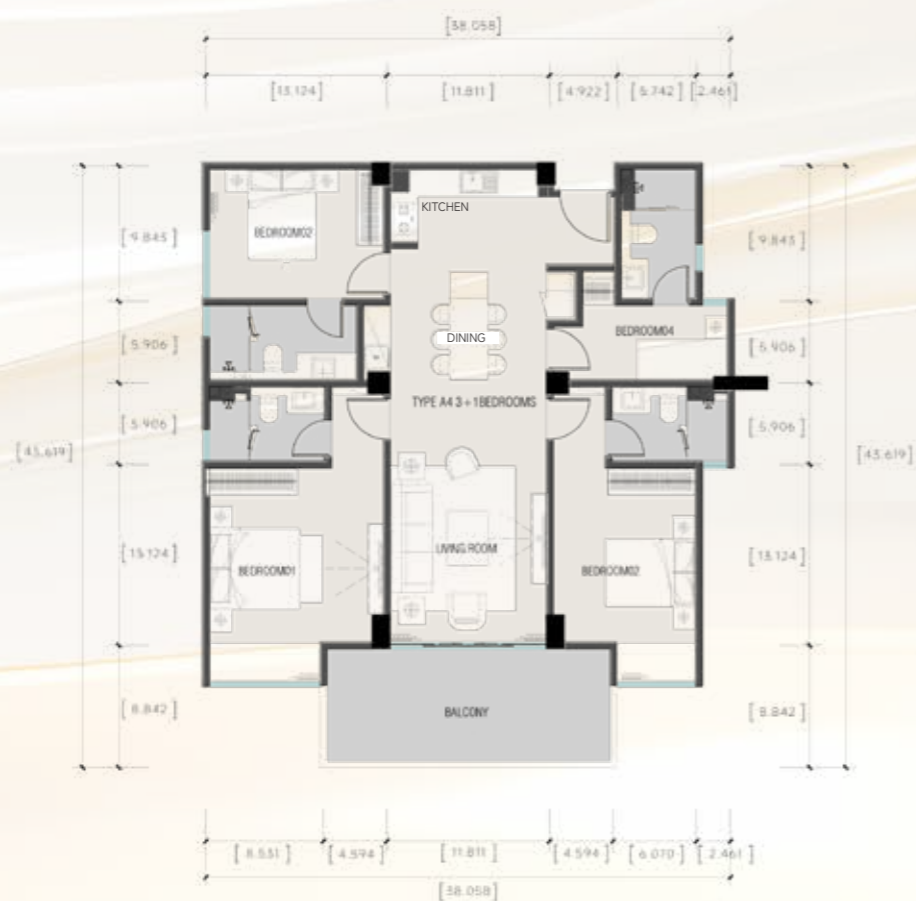

A4 Layout
3+1 BEDROOM
 Building area
1479.82 SQFT

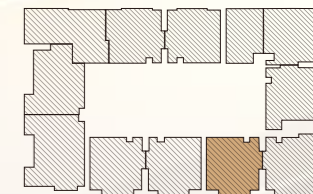

- Three bedrooms
- One living room
- Four bathrooms
- One kitchen
- Municipalities

- Easy: 3-room bright design, square and transparent floor plan, excellent space, multiple lifestyles to create a noble living style
- Perfection: Abundant lighting, imbuing natural freshness throughout.
- Efficiency: Every inch of space meticulously considered, featuring a scientifically rational design with high-performance attributes, ensuring practicality without wastage.
- Elegance: Open kitchen design, liberating: Impeccable open kitchen design, fostering culinary creativity and carefree enjoyment.
- Luxury: transparent layout, independent bathroom, enjoy the quiet time.

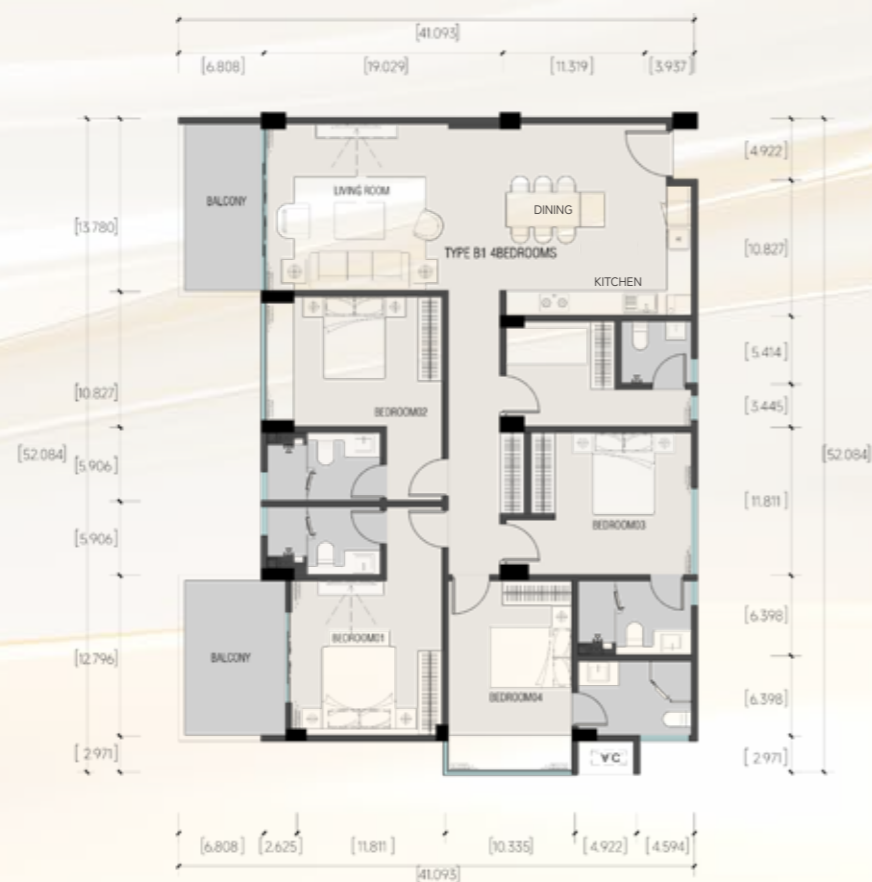

B1 Layout
4+1 BEDROOM
 Building area
1870.12 SQFT

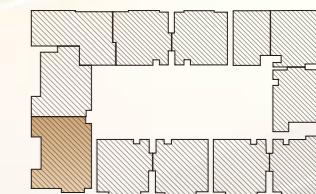





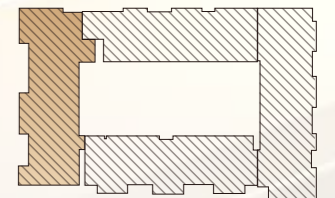

- Four bedrooms
- One living room
- Five bathrooms
- One kitchen
- Seascape

- Space: 4-room bright design, square and transparent house type, excellent space, a variety of life to create a noble style of living
- Design: Double balconies with large lighting surface, view the park and nature.
- Comfort: The open space is designed to enhance every aspect of a joyful life.
- Private: The villa suite, featuring a bathroom, offers an exclusive comfort zone for the Master suite.
- Utilization: Every inch of space has been carefully considered: the design is scientific and reasonable, boasting high-performance features, ensuring practicality without waste.



C Penthouse
 Building area
4895.96 SQFT



-  Four bedrooms
-  One living room
-  Six bathrooms
-  One kitchen
-  Seascape

- Effortless: 4-bedroom bright layout, square and transparent, offering excellent space for diverse lifestyles and cultivating a noble living style.
- Perfection: large-scale lighting surface, natural freshness everywhere
- Utilization: Every inch of space has been carefully considered: the design is scientific and reasonable, boasting high-performance features, ensuring practicality without waste.
- Elegance: Open kitchen design, gracefully blending functionality with exquisite aesthetics.
- Luxury: transparent layout, independent bathroom, enjoy the quiet time.

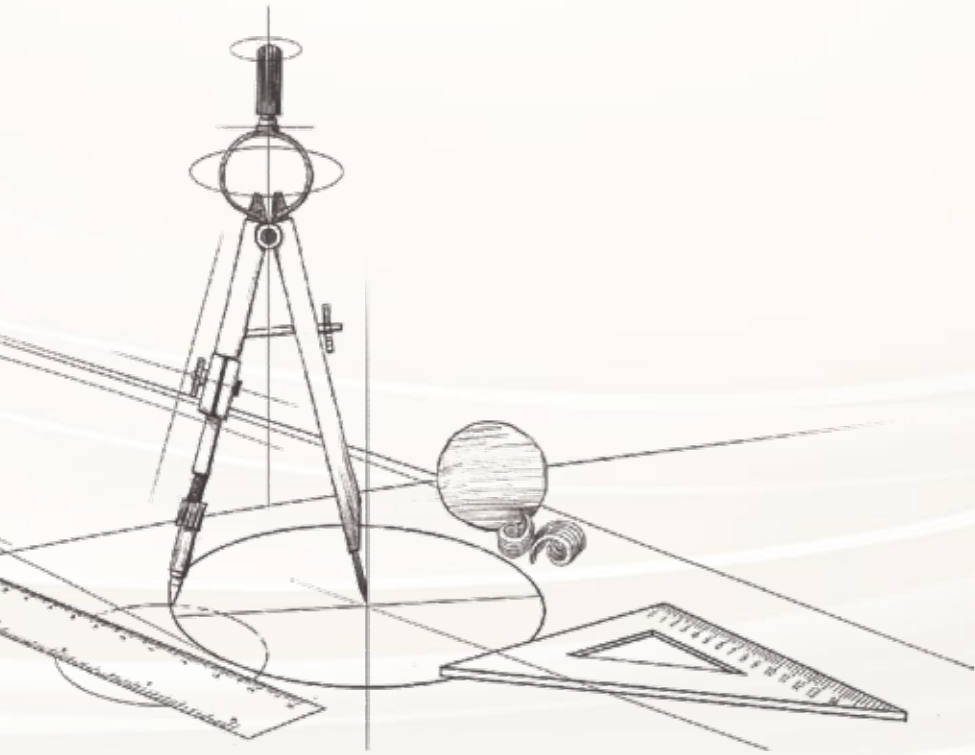

Kandoofaa is more than just a place to live; it stands as a symbol of your pride. Together, let's discover and experience the ideal future lifestyle right here, as this is where the journey towards a life of superior quality begins. No longer is there a need to search around the world for the perfect home; Kandoofaa is your most esteemed residence.